

FLUKE®

Biomedical

BP Pump 2

NIBP Simulator and Tester

Operators Manual

PN 2196592

June 2007

© 2007 Fluke Corporation, All rights reserved. Printed in USA
All product names are trademarks of their respective companies.

Warranty and Product Support

Fluke Biomedical warrants this instrument against defects in materials and workmanship for one year from the date of original purchase. During the warranty period, we will repair or at our option replace, at no charge, a product that proves to be defective, provided you return the product, shipping prepaid, to Fluke Biomedical. This warranty covers the original purchaser only and is not transferable. The warranty does not apply if the product has been damaged by accident or misuse or has been serviced or modified by anyone other than an authorized Fluke Biomedical service facility. **NO OTHER WARRANTIES, SUCH AS FITNESS FOR A PARTICULAR PURPOSE, ARE EXPRESSED OR IMPLIED. FLUKE SHALL NOT BE LIABLE FOR ANY SPECIAL, INDIRECT, INCIDENTAL OR CONSEQUENTIAL DAMAGES OR LOSSES, INCLUDING LOSS OF DATA, ARISING FROM ANY CAUSE OR THEORY.**

This warranty covers only serialized products and their accessory items that bear a distinct serial number tag. Recalibration of instruments is not covered under the warranty

This warranty gives you specific legal rights and you may also have other rights that vary in different jurisdictions. Since some jurisdictions do not allow the exclusion or limitation of an implied warranty or of incidental or consequential damages, this limitation of liability may not apply to you. If any provision of this warranty is held invalid or unenforceable by a court or other decision-maker of competent jurisdiction, such holding will not affect the validity or enforceability of any other provision.

07/07

Notices

All Rights Reserved

© Copyright 2007, Fluke Biomedical. No part of this publication may be reproduced, transmitted, transcribed, stored in a retrieval system, or translated into any language without the written permission of Fluke Biomedical.

Copyright Release

Fluke Biomedical agrees to a limited copyright release that allows you to reproduce manuals and other printed materials for use in service training programs and other technical publications. If you would like other reproductions or distributions, submit a written request to Fluke Biomedical.

Unpacking and Inspection

Follow standard receiving practices upon receipt of the instrument. Check the shipping carton for damage. If damage is found, stop unpacking the instrument. Notify the carrier and ask for an agent to be present while the instrument is unpacked. There are no special unpacking instructions, but be careful not to damage the instrument when unpacking it. Inspect the instrument for physical damage such as bent or broken parts, dents, or scratches.

Technical Support

For application support or answers to technical questions, either email techservices@flukebiomedical.com or call 1-800- 648-7952 or 1-425-446-6945.

Claims

Our routine method of shipment is via common carrier, FOB origin. Upon delivery, if physical damage is found, retain all packing materials in their original condition and contact the carrier immediately to file a claim. If the instrument is delivered in good physical condition but does not operate within specifications, or if there are any other problems not caused by shipping damage, please contact Fluke Biomedical or your local sales representative.

Standard Terms and Conditions

Refunds and Credits

Please note that only serialized products and their accessory items (i.e., products and items bearing a distinct serial number tag) are eligible for partial refund and/or credit. Nonserialized parts and accessory items (e.g., cables, carrying cases, auxiliary modules, etc.) are not eligible for return or refund. Only products returned within 90 days from the date of original purchase are eligible for refund/credit. In order to receive a partial refund/credit of a product purchase price on a serialized product, the product must not have been damaged by the customer or by the carrier chosen by the customer to return the goods, and the product must be returned complete (meaning with all manuals, cables, accessories, etc.) and in “as new” and resalable condition. Products not returned within 90 days of purchase, or products which are not in “as new” and resalable condition, are not eligible for credit return and will be returned to the customer. The Return Procedure (see below) must be followed to assure prompt refund/credit.

Restocking Charges

Products returned within 30 days of original purchase are subject to a minimum restocking fee of 15 %. Products returned in excess of 30 days after purchase, but prior to 90 days, are subject to a minimum restocking fee of 20 %. Additional charges for damage and/or missing parts and accessories will be applied to all returns.

Return Procedure

All items being returned (including all warranty-claim shipments) must be sent freight-prepaid to our factory location. When you return an instrument to Fluke Biomedical, we recommend using United Parcel Service, Federal Express, or Air Parcel Post. We also recommend that you insure your shipment for its actual replacement cost. Fluke Biomedical will not be responsible for lost shipments or instruments that are received in damaged condition due to improper packaging or handling.

Use the original carton and packaging material for shipment. If they are not available, we recommend the following guide for repackaging:

- Use a double-walled carton of sufficient strength for the weight being shipped.
- Use heavy paper or cardboard to protect all instrument surfaces. Use nonabrasive material around all projecting parts.
- Use at least four inches of tightly packed, industry-approved, shock-absorbent material around the instrument.

Returns for partial refund/credit:

Every product returned for refund/credit must be accompanied by a Return Material Authorization (RMA) number, obtained from our Order Entry Group at 1-800-648-7952 or 1-425-446-6945.

Repair and calibration:

To find the nearest service center, go to www.flukebiomedical.com/service, or

In the U.S.A.:

Cleveland Calibration Lab
Tel: 1-800-850-4606
Email: globalcal@flukebiomedical.com

Everett Calibration Lab
Tel: 1-888-993-5853
Email: service.status@fluke.com

In Europe, Middle East, and Africa:

Eindhoven Calibration Lab
Tel: +31-402-675300
Email: ServiceDesk@fluke.com

In Asia:

Everett Calibration Lab
Tel: +425-446-6945
Email: service.international@fluke.com

Certification

This instrument was thoroughly tested and inspected. It was found to meet Fluke Biomedical's manufacturing specifications when it was shipped from the factory. Calibration measurements are traceable to the National Institute of Standards and Technology (NIST). Devices for which there are no NIST calibration standards are measured against in-house performance standards using accepted test procedures.

WARNING

Unauthorized user modifications or application beyond the published specifications may result in electrical shock hazards or improper operation. Fluke Biomedical will not be responsible for any injuries sustained due to unauthorized equipment modifications.

Restrictions and Liabilities

Information in this document is subject to change and does not represent a commitment by Fluke Biomedical. Changes made to the information in this document will be incorporated in new editions of the publication. No responsibility is assumed by Fluke Biomedical for the use or reliability of software or equipment that is not supplied by Fluke Biomedical, or by its affiliated dealers.

Manufacturing Location

The BP Pump 2 Non-invasive Blood Pressure Simulator and Tester is manufactured in Everett, Washington by Fluke Biomedical, 6920 Seaway Blvd., Everett, WA, U.S.A.

Table of Contents

Chapter	Title	Page
1	Introduction and Specifications	1-1
	Introduction	1-3
	Key Features	1-3
	General Safety Considerations	1-4
	Symbols	1-4
	Warnings and Cautions	1-5
	Instrument Familiarity	1-7
	Powering Up the Tester	1-10
	Specifications	1-10
	Accessories	1-12
2	Setup, Maintenance, and Support	2-1
	Setting up the Tester	2-3
	Printer Output	2-4
	User-Defined Simulations	2-5
	Language	2-6
	Units of Measure	2-6
	Self Test	2-8
	Zero Pressure	2-8
	Enable ECG Signal	2-9
	Maintenance and Support	2-10
	Avoiding Damage	2-10
	Cleaning	2-10
	Service and Calibration	2-11
	Packing Instructions	2-11
3	Operation	3-1
	Introduction	3-3
	Configurations for Devices Under Test (DUT)	3-4
	Conversion Factors	3-7
	Initializing Tests and Simulations	3-7
	Error Messages	3-7

Pressure Tests.....	3-8
Pressure Leak Test.....	3-8
Pressure Relief Test.....	3-10
Pressure Source Test.....	3-11
Pressure Gauge Test.....	3-12
Simulations.....	3-13
Standard BP.....	3-14
Patient Conditions.....	3-15
Arrhythmias.....	3-16
Respiratory Artifacts.....	3-18
Neonate.....	3-19
Wrist.....	3-20
User-Defined.....	3-21
Auto Sequences.....	3-21
Editing Auto Sequences.....	3-22
Printing Auto Sequences.....	3-23
Running Auto Sequences.....	3-24
Pressure Gauge.....	3-25
Leak Test.....	3-25
Relief Valve Test.....	3-26
Pressure Source.....	3-26
Data Sheet Printout.....	3-27
BP Simulations.....	3-27
Remote Operation.....	3-29
RS-232 Settings.....	3-29
Ansur Software Control.....	3-29

Appendices

A	ECG Interface.....	A-1
B	Questions and Answers.....	B-1
C	Abbreviations.....	C-1
D	Computer Control Commands.....	D-1

List of Tables

Table	Title	Page
1-1.	Symbols	1-4
1-2.	Top and Side Panel Components	1-8
1-3.	Number Key Functions	1-9
1-4.	Standard Accessories	1-12
1-5.	Optional Accessories	1-12
3-1.	Conversion Factors	3-7
3-2.	Standard Blood Pressure Simulations	3-15
3-3.	Patient Condition Simulations	3-16
3-4.	Arrhythmia Simulations	3-17
3-5.	Respiratory Artifact Simulations	3-18
3-6.	Neonate Simulations	3-19
3-7.	Wrist Simulations	3-20
D-1.	Computer Control Commands	D-1

List of Figures

Figure	Title	Page
1-1.	Tester Top and Side Panel Components	1-7
3-1.	Tester Pneumatic Block Diagram	3-3
3-2.	Connecting Tester to Single-hose NIBP Monitor (Int Cuff).....	3-4
3-3.	Connecting Tester to Double-hose NIBP Monitor (Int Cuff).....	3-5
3-4.	Connecting Tester to Single-hose NIBP Monitor (Ext Cuff).....	3-5
3-5.	Connecting Tester to Double-hose NIBP Monitor (Ext Cuff).....	3-6
3-6.	Connecting Tester to Single-hose NIBP Wrist Monitor (Ext Cuff)	3-6
3-7.	Sample Auto Sequence Test Printout.....	3-24
3-8.	Sample Data Sheet Printout	3-28
A-1.	Optional ECG Interface Adapter.....	A-1

Chapter 1

Introduction and Specifications

Contents	Page
Introduction	1-3
Key Features	1-3
General Safety Considerations	1-4
Symbols	1-4
Warnings and Cautions	1-5
Instrument Familiarity	1-7
Powering Up the Tester	1-10
Specifications	1-10
Accessories	1-12

Introduction

The Fluke Biomedical BP Pump 2 Non-Invasive Blood Pressure Simulator and Tester, hereafter known as the “Tester”, is a multi-purpose test instrument for use with oscillometric Non-Invasive Blood Pressure Monitors (NIBPMs). The Tester provides dynamic blood pressure simulations, static calibration, automated leak testing, and pressure relief valve testing. The following models are available:

- BP Pump 2L (Basic Model)
- BP Pump 2M (High-Accuracy Model)

The Tester allows you to verify the performance claims of different blood pressure monitors. You can quickly recall the fixed onboard simulations or define your own. With its internal pump, the Tester can generate pressures up to 400 mmHg (53.3 kPa) for leak testing, pressure sourcing, and relief valve testing.

In addition, you can define auto sequences that automate the sequencing of tests and NIBP simulations and provide an optional printed report.

Key Features

Key features of the Tester include:

- Pressure leak testing on cuff, tubing, and connections
- Relief valve testing on the patient monitor
- Pressure gauge measurements
- Pressure source capability
- NIBP simulations including adult, neonate, arrhythmias, and respiratory artifacts
- Auto sequences with optional reports
- Internal Adult and Neonatal Cuff simulation

Tester capabilities can be extended with optional accessories that allow:

- ECG synchronization with non-invasive output
- External wrist cuff simulations

Tester pressure accuracy can be improved by upgrading to a high-accuracy pressure transducer. This is a factory service upgrade and is provided to customers wanting to meet the DIN EN 1060 requirements for pressure measurement accuracy. For more information, refer to “Setup, Maintenance, and Support: Maintenance and Support.”

General Safety Considerations





This Tester complies with safety and technical requirements described in the following directives:

- UL 3101-1, Electrical Equipment for Laboratory Use; Part 1: General Requirements.
- CAN/CSA C22.2 No. 1010.1 (1992), Safety Requirements for Electrical Equipment for Measurement, Control and Laboratory Use, Part 1: General Requirements.
- EC 73/23/EEC (Amended 93/68/EEC) EN61010-1:2001, Safety requirement for electrical equipment for measurement, control and laboratory use, Part 1: General Requirements.

Symbols

Table 1-1 describes symbols used in association with the Tester.

Table 1-1. Symbols

Symbol	Description	Symbol	Description
	Risk of danger. Important information. See manual.		Hazardous voltage. Risk of electrical shock.
	Intertek Electrical Test Laboratory listed. Conforms to relevant Canadian and U.S. standards.		Conforms to European Union directives
	Do not dispose of this product as unsorted municipal waste. Contact Fluke or a qualified recycler for disposal.		

Warnings and Cautions

Users are advised to read the manual carefully, observing all warnings and cautions, before attempting to set up and operate the Tester.

A **Warning** identifies hazardous conditions and actions that could cause bodily harm or death.

A **Caution** identifies conditions and actions that could damage the Tester or the equipment under test, or cause permanent loss of data.

⚠ ⚠ Warning

To avoid possible electric shock or personal injury, follow these guidelines:

- **Read the Users Manual before operating the Tester.**
- **Use this Tester only in the manner specified by the manufacturer or the protection provided may be impaired.**
- **Do not connect the Tester to a patient or equipment connected to a patient. The Tester is intended for equipment evaluation only and should never be used in diagnostics, treatment or in any other capacity where the Tester would come in contact with a patient.**
- **Do not use the product in wet locations, around explosive gases or dust.**
- **Never open the Tester case, because dangerous voltages are present. There are no user replaceable parts in the Tester.**
- **The Tester must be properly earthed. Only use a supply socket that has a protective earth contact. If there is any doubt as to the effectiveness of the supply socket earth, do not connect the Tester.**
- **Do not use a two-conductor adapter or extension cord; this will break the protective ground connection.**
- **Ensure that the external power source is properly rated for the system.**

- **Always connect the system power cord directly to a three-prong receptacle with a functional ground. Never use a two-prong plug adapter to connect primary power to the Tester, thereby disconnecting the utility ground.**
- **Disconnect the Tester from the power source before changing the supply voltage. The Tester operates at a range of 100 to 240 volts.**

⚠ Caution

To avoid damage to the Tester or adverse affects on its performance, follow these guidelines:

- **Allow only qualified technical personnel to service the Tester.**
- **Do not expose the system to temperature extremes. Ambient temperatures should remain between 15° C and 40° C. System performance may be adversely affected if temperatures fluctuate above or below this range.**
- **Clean the Tester only by gently wiping down with a clean, lint-free cloth dampened with a mild detergent solution. Do not immerse the unit.**
- **Do not apply pressures greater than 400 mmHg (53 kPa) to the pressure port.**

Instrument Familiarity

Figure 1-1 shows the Tester. The top and side panel components are described in Table 1-2 and the number key functions are described in Table 1-3.

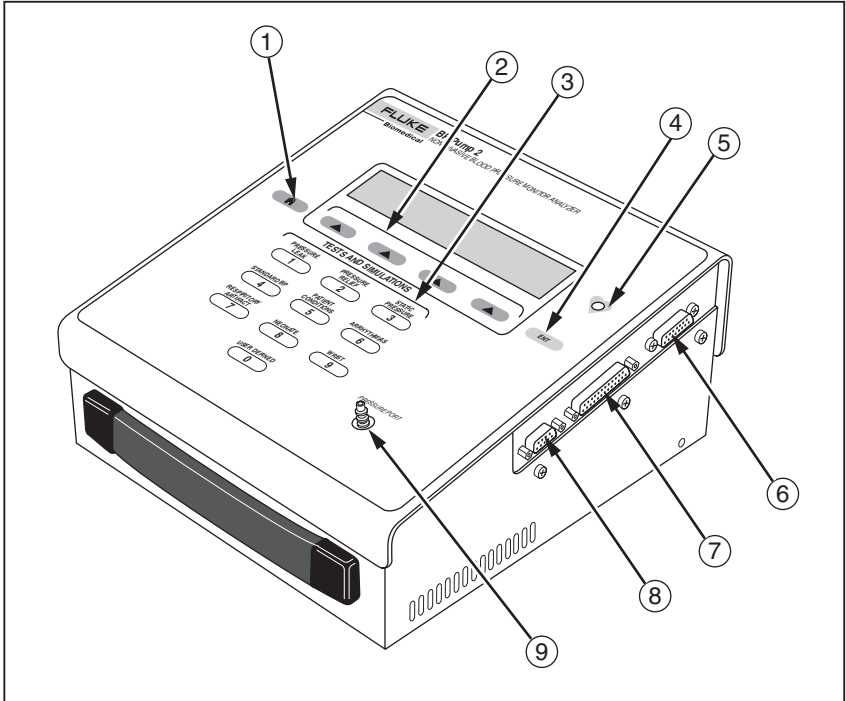

Figure 1-1. Tester Top and Side Panel Components

fas10.eps

Table 1-2. Top and Side Panel Components

Label	Name	Function
①	Home Key	Returns the operator to the Main Menu.
②	Soft Keys 1 - 4	Makes dynamic assignments based on the current screen.
③	Number (Test and Simulations) Keys	Allows the operator to perform auto sequences and simulations using numeric keys.
④	Enter Key	Advances to the next menu or saves/selects options.
⑤	Pulse Indicator	LED blinks in synchronization with beeper, indicating that the pump is generating a simulated blood pressure pulse.
⑥	ECG Interface Port	Allows connection of optional ECG accessory (refer to Appendix, ECG Option).
⑦	Printer Port	Provides D-25 female connector for external parallel printer.
⑧	RS-232 Serial Port	Provides serial D-9 female connector for bi-directional computer control.
⑨	Pressure Port	Connects to the Non-Invasive Blood Pressure Monitor for all pressure simulations and tests.

Table 1-3. Number Key Functions

Number	Name	Function
1	PRESSURE LEAK	Pressurizes a pneumatic system to an operator-defined target pressure up to 400 mmHg (53.3 kPa) and then measures the loss of pressure over time.
2	PRESSURE RELIEF	Increases the pressure in the pneumatic system until the relief valve on the NIBP monitor opens or until the Setpoint is reached, whichever occurs first.
3	STATIC PRESSURE	Accessed via the Pressure Gauge Test, which enables the Tester to measure static pressure generated by an external source in the range of 50 to 400 mmHg 6.7 to 53.3 kPa).
4	STANDARD BP	Provides seven variations of NIBP simulations for both arm and wrist cuffs.
5	PATIENT CONDITIONS	Includes simulations for healthy, geriatric, and obese patients, a well as various levels of exercise.
6	ARRHYTHMIAS	Measures erratic heart rhythms, including atrial fibrillation and premature ventricular contraction.
7	RESPIRATORY ARTIFACT	Exhibits a beat-to-beat variation in the blood pressure caused by intrathoracic pressure.
8	NEONATE	Tests the ability of the NIBP monitors to detect blood pressure on neonatal patients.
9	WRIST	Tests wrist cuff NIBP monitors.
0	USER DEFINED	Allows the operator to define blood pressure simulations.

Powering Up the Tester

The Tester is very simple to power up. Follow these steps:

1. Plug in a three-pronged power cord to the back of the unit.
2. Plug the cord into an appropriate socket, ensuring that the external power source is properly rated for the system.
3. Move the power switch above the plug to the on position. After two momentary screens, the Tester displays the **Main** menu, from which all Tester functions are selected.

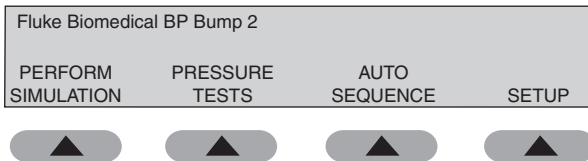

fas31.eps

Specifications

The following are specifications for the Tester. Please contact your Fluke Biomedical service representative for more information regarding the device specifications.

Mains Voltage

Range100 - 240 V ac 50/60 Hz, 60 VA

Environmental Conditions

Operating Temperature15 °C to 40 °C
Storage Temperature-20 °C to +65 °C
Relative Humidity90 % max

Pressure Measurement

UnitskPa
mmHg
cmH₂O
inH₂O
psi

Range	0 mmHg to +400 mmHg
Resolution	0.1 kPa 1 mmHg 1 cmH ₂ O 1 inH ₂ O 0.1 psi
Resolution (High Accuracy Version)	0.01 kPa 0.1 mmHg 0.1 cmH ₂ O 0.1 inH ₂ O 0.01 psi
Accuracy (Standard Version)	
0 to 300 mmHg	±0.5 % of reading ±1 mmHg
301 to 400 mmHg	±2 % of reading
High-Accuracy Version	<0.8 mmHg (0.1 kPa)

Pressure Generation

Pressure Generator, Static Pressure Range	50 mmHg to +400 mmHg
Difference between target pressure and actual pressure	±10 mmHg from 100-400 mmHg with a minimum volume of 300 cc
Internal Leak Rate	<2 mmHg per minute, with a minimum volume of 300 cc

Electrical ECG

Signals	RA, LA, RL, LL, V
Waveform	Lead II
Amplitude	1 mV peak (±10%)
Connections	Signals available via the optional ECG adapter

Heart Rate for NIBP Simulations

Heart Rate Accuracy	
With ECG disabled	±1 BPM
With ECG enabled	±1 BPM
Except for the following Patient Conditions:	
Weak Pulse, Tachycardia, Obese, Geriatric	±1% ±1 BPM
Patient Condition Mild Exercise	±1.5% ±1 BPM
Patient Condition Strenuous Exercise	±3% ±1 BPM

Accessories

The following are accessories for the Tester. To order, contact your Fluke Biomedical equipment dealer and use the Fluke Biomedical part numbers provided. Table 1-4 lists standard accessories shipped with the tester. Table 1-5 lists optional accessories that must be ordered separately.

Table 1-4. Standard Accessories

Description	Quantity Shipped	Part Number
Operator's Manual	1	2196592
Warranty Card	1	2241856
Tubing and Fittings	1	2196394
Country-specific Power Cord		
USA	1	284174
Schuko	1	769422
UK	1	769455
AU	1	658641

Table 1-5. Optional Accessories

Description	Part Number
Wrist Cuff Mandrel	2391875
ECG adapter	2391894
Carrying Case	2222822
RS-232 Serial Cable (9M-9F)	2238659
BP Pump 2 Ansur Plug-In	2755836

Chapter 2

Setup, Maintenance, and Support

Contents	Page
Setting up the Tester.....	2-3
Printer Output.....	2-4
User-Defined Simulations.....	2-5
Language.....	2-6
Units of Measure.....	2-6
Self Test.....	2-8
Zero Pressure.....	2-8
Enable ECG Signal.....	2-9
Maintenance and Support.....	2-10
Avoiding Damage.....	2-10
Cleaning.....	2-10
Service and Calibration.....	2-11
Packing Instructions.....	2-11

Setting up the Tester

To set up the tester, carry out the following:

1. Insert the power cord into the Tester and plug the cord into an appropriate ac power socket.

⚠ ⚠ Warning

To avoid possible electric shock, burning of the skin, or personal injury, ensure that the external power source is properly rated for the system.

2. Turn the power switch on. When the Tester is powered up, the **Main** menu appears.

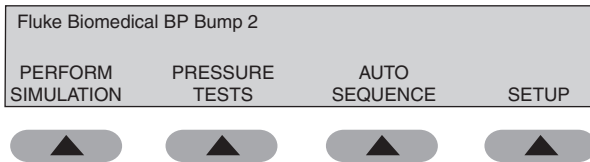

fas31.eps

3. The Tester has several configurable options available from the **Setup** menu. You can reach the **Setup** menu by using the soft keys to follow the menu path shown below:

MAIN MENU → SETUP

The **Setup** menu appears, showing the following configurable options:

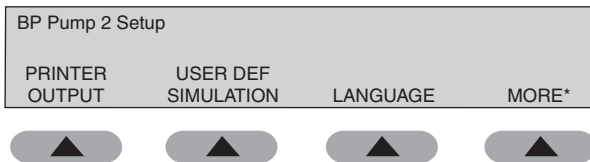

fas37.eps

4. Press the **MORE** soft key in this and each of the following screens to display additional options:

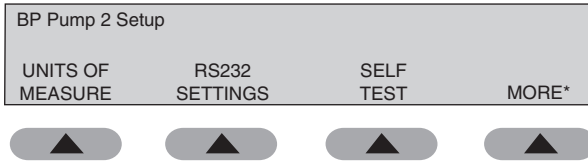

fas38.eps

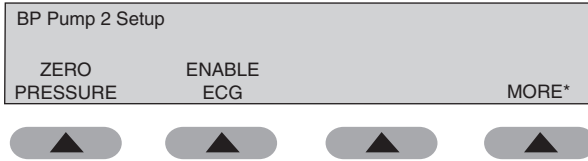

fas39.eps

Note

These parameters should be configured and the settings saved the first time the Tester is used. They need to be configured only once.

Printer Output

Printouts are available for auto sequences. By default, the Printer Output is set to **NONE**.

To control the production of when running auto sequences, take the following actions:

1. Select the desired print format by using the soft keys to follow the menu path shown below.

SETUP → PRINTER OUTPUT

The **Printer Output** screen appears, showing the available options:

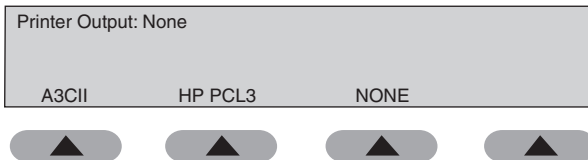

fas22.eps

2. Select one option and press **ENT** to return to the **SETUP** menu.
3. If desired, press **HOME** to return to the **Main** menu.

User-Defined Simulations

The Tester supports up to nine user-definable blood pressure simulations configured through the **Setup** menu.

To access and modify a user-defined simulation definition, take the following actions:

1. Use the soft keys to follow this menu path:

SETUP → **USER DEF SIMULATION** → **Number Key (1-9)** → **ENT**

2. Alternatively, you can access the definition from the number keys:

0 USER DEFINED key → **OPTIONS (to scroll through the numbers)** → **EDIT**

With either method, the **User Defined Simulation** screen appears:

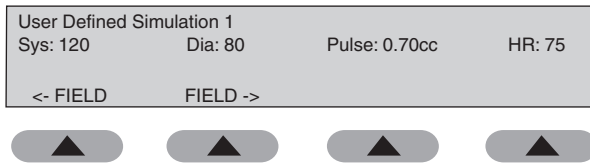

fas23.eps

This screen shows the number of the simulation, along with the following parameters available for configuration. Their valid ranges are as follows:

- **Sys:** Systolic, 20 – 250 mmHg
- **Dia:** Diastolic, 10 – 200 mmHg
- **Pulse:** Pulse Volume, 0.1 cc – 2.4 cc in increments of 0.1 cc
- **HR:** Heart Rate, 30 – 250 bpm

The systolic and diastolic settings are interdependent. The diastolic must always be below the systolic. The pulse volume and the heart rate are also interdependent. The maximum pulse volume cannot be achieved at the maximum heart rate.

3. Press the soft key **<- FIELD** or **FIELD ->** to scroll through options, making changes to each field by entering numbers from the number keys.
4. Press **ENT** to return to the **SETUP** menu.
5. If desired, press the **HOME** button to return to the **Main** menu.

Language

Besides the default of English, the Tester can support up to four additional languages. Spanish is currently available; additional languages will be released in the future.

To change the language, take the following actions:

1. Use the soft keys to follow the menu path shown below.

SETUP → LANGUAGE

The **Display/Print Language** screen appears, showing the available options:

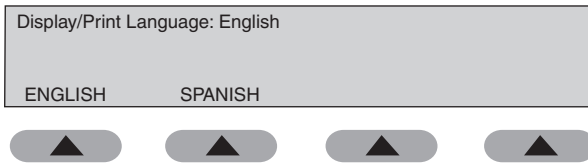

fas24.eps

2. Select a language by pressing its soft key.
3. When finished, press **ENT** to return to the **SETUP** menu.
4. If desired, press **HOME** to return to the **Main** menu.

Units of Measure

The Tester has separate definable measurement units for blood pressure simulations and pressure tests. For the blood pressure simulations, units of mmHg (default) and kPa are available. For the pressure tests, units of mmHg (default), kPa, cmH₂O, inH₂O, and PSI are available.

To define the pressure units, do the following:

1. Use the soft keys to follow the menu path shown below.

SETUP → *MORE → UNITS OF MEASURE

The **Blood Pressure Units:** screen appears, showing the available options:

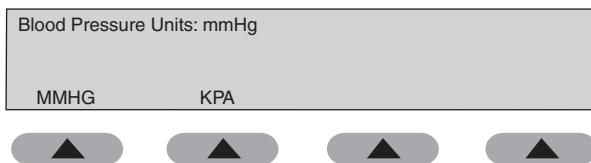

fas25.eps

2. Select one option and press **ENT**.

The **Pressure Measurement Units**: screen appears, showing the available options:

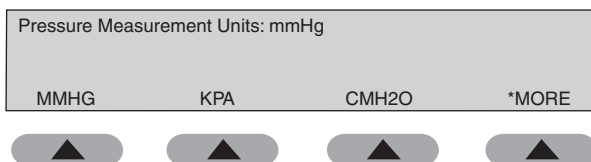

fas26.eps

3. Press ***MORE** to see additional options:

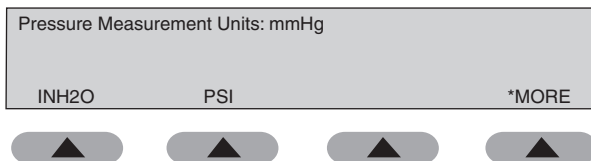

fas27.eps

4. Select one of the desired options and press **ENT** to return to the **Setup** menu.
5. If desired, press **HOME** to return to the **Main** menu.

Note

*Changing the **UNITS OF MEASURE** also changes the units used in the auto sequences.*

Self Test

The tester runs a self test, displaying the software version and checksum, the serial number, and the model number. A motor check is also performed.

To run a self test, do the following:

1. Use the soft keys to follow the menu path shown below.

SETUP → *MORE → SELF TEST

The **Self Test** screen appears:

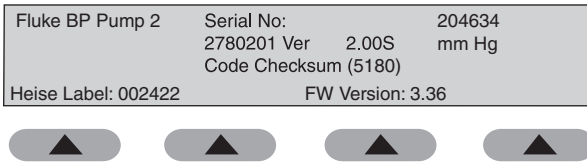

fas28.eps

2. When finished, press **ENT** to return to the **Setup** menu.
3. If desired, press **HOME** to return to the **Main** menu.

Zero Pressure

The Zero pressure option allows the user to re-zero the pressure. The function is similar to the tare of a scale. This re-zeroing lasts until the unit is zeroed again or until the power is shut off.

To zero the pressure, do the following:

1. Use the soft keys to follow the menu path shown below.

SETUP → MORE → MORE → ZERO PRESSURE

The **Zero Pressure (Remove connection ...)** screen appears:

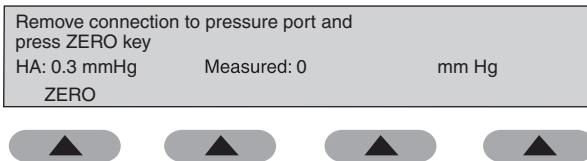

fas29.eps

2. When finished, press **ENT** to return to the **Setup** menu.

3. If desired, press **HOME** to return to the **Main** menu.

Enable ECG Signal

The ECG output is enabled or disabled by the operator. If the patient monitor under test does not make use of ECG signals, we recommend that the ECG output be disabled. (The factory default is for ECG to be disabled.) ECG signals are present for all Standard BP, Patient Condition, and Arrhythmia NIBP simulations. The ECG signals are present on the ECG Interface Port as shown in Figure 1-2. An optional ECG Interface adapter, as described in Appendix A, is available for purchase.

To enable or disable ECG signals, take the following actions:

1. Use the soft keys to follow the menu path shown below.

SETUP → *MORE → MORE → ENABLE ECG

The **Enable ECG?** screen appears, showing options **YES** and **NO**:

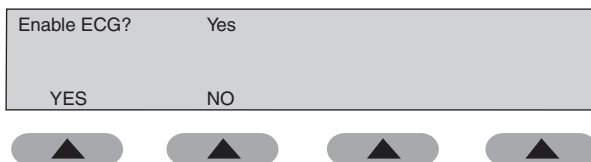

fas30.eps

2. Select one option and press **ENT** to return to the **Setup** menu.
3. If desired, press **HOME** to return to the **Main** menu.

Maintenance and Support

The Tester requires little maintenance or special care; however, it is a calibrated measuring instrument and should be treated as such. The following describes how to maintain the Tester and the method of company support.

Avoiding Damage

Do not drop the instrument or subject it to any mechanical abuse that could cause a shift in the calibrated settings.

⚠ Caution

To avoid damage to the Tester or adverse affects on its performance, follow these guidelines:

- **Do not expose the system to temperature extremes. Ambient temperatures should remain between 15 and 40 °C. System performance may be adversely affected if temperatures fluctuate above or below this range.**
- **Do not apply pressures greater than 400 mmHg (53 kPa) to the pressure port.**

Cleaning

Clean the exterior of the Tester occasionally with a cloth dampened with a mild detergent solution. Take care to keep liquids out of the pressure port.

⚠ Caution

To avoid damage to the Tester or adverse affects on its performance, clean it only by gently wiping down with a clean, lint-free cloth dampened with a mild detergent solution. Do not immerse the unit.

Carefully wipe down the hose adapters and inspect them for damage and deterioration of the tubing and fittings.

Service and Calibration

If the Tester fails to operate successfully, please contact the Fluke Biomedical Service Center immediately, as indicated under “Warranty and Product Support.”

⚠ Caution

To avoid damage to the Tester or adverse affects on its performance, allow only qualified technical personnel to service the Tester.

Annual calibration of the Tester by an authorized Fluke Biomedical Service Center is recommended. Fluke Biomedical Service Centers have the appropriate tools and procedures for performing calibrations as well as factory-authorized updates.

International customers should contact their Fluke Biomedical dealers for service/product support.

To obtain the name of a local dealer or service center, contact Fluke Biomedical as indicated under “Return Procedures, Repair and Calibration.”

Packing Instructions

If repairs are required, return the Tester to the factory or the nearest service center, packed in the original shipping container, using packing materials supplied by Fluke Biomedical.

1. Before returning the Tester for factory service, contact the Fluke Biomedical Service Center for a required Return Authorization Number.
2. Provide the following information:
 - The Tester serial number
 - The specific steps that reproduce the problem
 - A daytime phone number
 - Your name/company
 - A fax number (if available)
3. Pack the instrument carefully, using the original packing materials. If the original packing materials are not available, refer to “Return Procedures”

for a list of preferred materials or contact Fluke Biomedical for replacement packing. Failure to pack the instrument properly could void your warranty.

4. Place the Return Authorization Number in a prominent place on the outside of the packing box, and refer to the number in any correspondence with Fluke Biomedical Service.
5. Enclose your return address and Return Authorization Number.
6. Insure the unit for full retail value and ship to the nearest Fluke Biomedical service center.

Chapter 3

Operation

Contents	Page
Introduction	3-3
Configurations for Devices Under Test (DUT)	3-4
Conversion Factors	3-7
Initializing Tests and Simulations	3-7
Error Messages	3-7
Pressure Tests	3-7
Pressure Leak Test	3-8
Pressure Relief Test	3-9
Pressure Source Test	3-11
Pressure Gauge Test	3-12
Simulations	3-13
Standard BP	3-14
Patient Conditions	3-15
Arrhythmias	3-16
Respiratory Artifacts	3-18
Neonate	3-19
Wrist	3-20
User-Defined	3-21
Auto Sequences	3-21
Editing Auto Sequences	3-22
Printing Auto Sequences	3-23
Running Auto Sequences	3-24
Pressure Gauge	3-25
Leak Test	3-25
Relief Valve Test	3-26
Pressure Source	3-26
Data Sheet Printout	3-27
BP Simulations	3-27
Remote Operation	3-29
RS-232 Settings	3-29
Ansur Software Control	3-29

Introduction

The Tester contains a microprocessor that reads and controls the front panel keyboard, the display, serial port, printer port, a diaphragm pump, two solenoid valves, a step motor, a position sensor, and a pressure transducer (Figure 3-1).

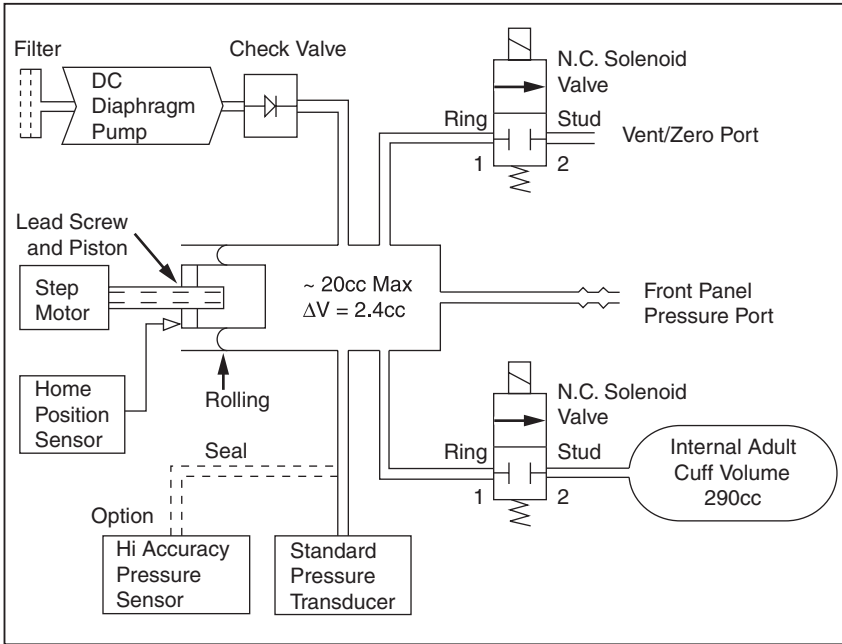

fas14.eps

Figure 3-1. Tester Pneumatic Block Diagram

The diaphragm pump is used as a pressure source for the relief valve, leak, and pressure source tests. The diaphragm pump pulls air through a filter and forces it through a check valve into the main manifold of the instrument. This main manifold has an internal volume of approximately 20 cc and is directly connected to the pressure port on the front panel. Pressure in the manifold is measured by a pressure transducer and can be released by a solenoid-operated valve. The volume of the main manifold can be increased by approximately 290 cc, to simulate an adult pressure cuff, by opening a second solenoid valve.

A stepper motor and lead screw move a piston into the manifold to decrease the manifold volume, thereby creating pressure pulses to simulate a human subject. A seal around the piston is maintained by a rolling diaphragm seal. The size and

shape of the pulses are controlled by the microprocessor driving the step motor. The home position of the piston is detected by an optical interrupter. If the optional high-accuracy pressure sensor is installed, it also measures the pressure in the main manifold and is also controlled by the microprocessor.

Configurations for Devices Under Test (DUT)

Connect the Tester to the NIBPM unit with the tubing and fittings (part number 2391882) supplied with the Tester in the desired configurations, as shown in Figures 3-2 through 3-6.

Basically, configurations involve connecting the NIBPM unit to the Tester directly or connecting the unit, a cuff, and the Tester, using a “T” connector. When connected properly, the tubing forms a closed system with the components.

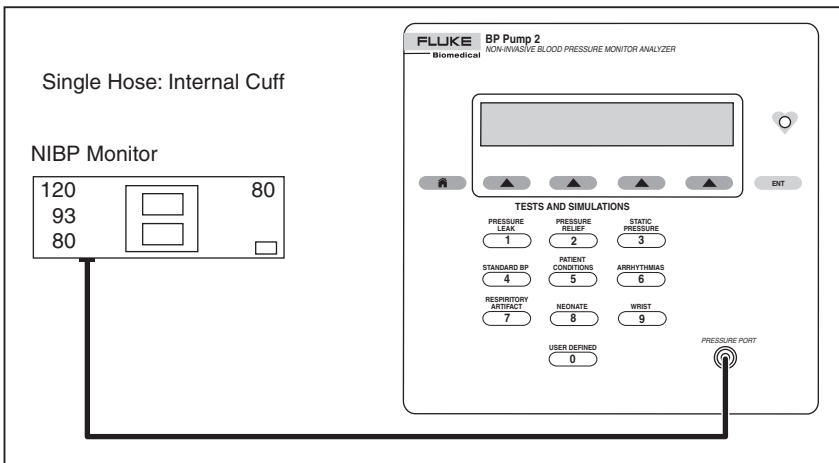
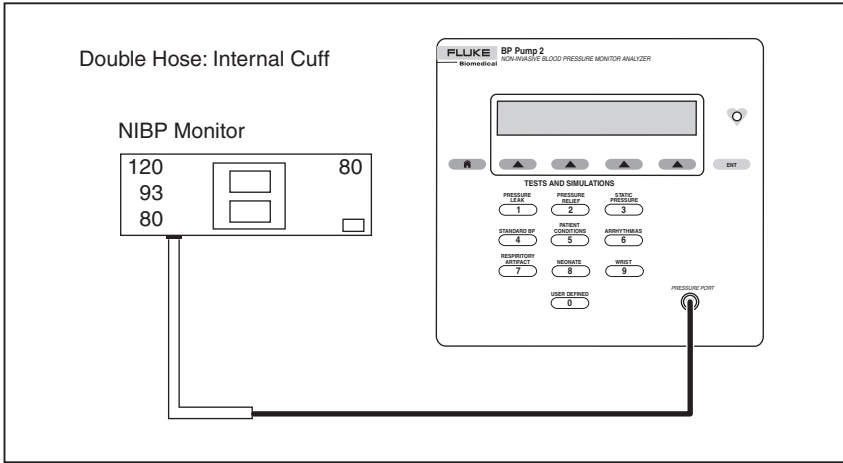

Figure 3-2. Connecting Tester to Single-hose NIBP Monitor (Int Cuff)

fas16.eps



fas17.eps

Figure 3-3. Connecting Tester to Double-hose NIBP Monitor (Int Cuff)

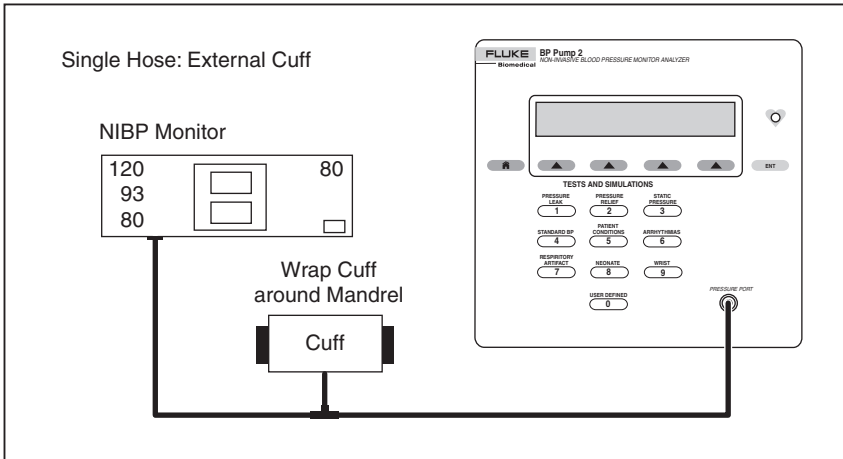

fas18.eps

Figure 3-4. Connecting Tester to Single-hose NIBP Monitor (Ext Cuff)

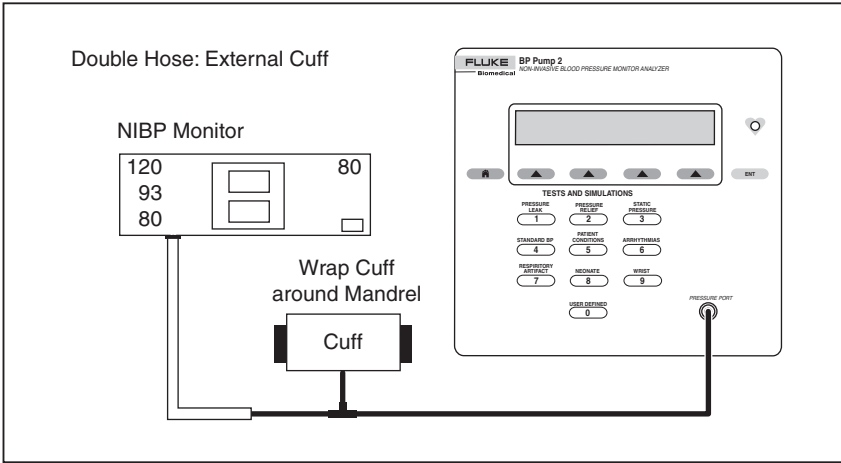

fas19.eps

Figure 3-5. Connecting Tester to Double-hose NIBP Monitor (Ext Cuff)

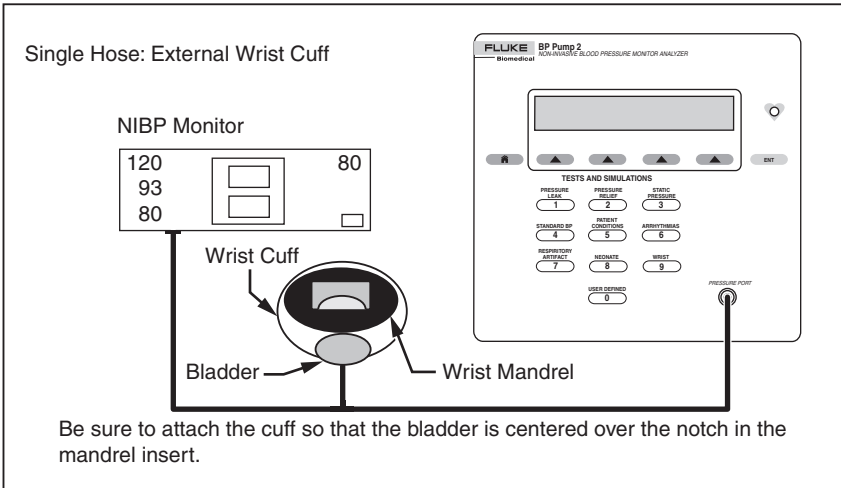

Be sure to attach the cuff so that the bladder is centered over the notch in the mandrel insert.

fas20.eps

Figure 3-6. Connecting Tester to Single-hose NIBP Wrist Monitor (Ext Cuff)

Conversion Factors

Conversion factors for the Tester are shown in Table 3-1.

Table 3-1. Conversion Factors

Units	mmHg
PSI_PER_MMHG	0.019337
CMH2O_PER_MMHG	1.3595
INH2O_PER_MMHG	0.53525
KPA_PER_MMHG	0.13332

Initializing Tests and Simulations

You can access functions of the Tester in two ways:

- Exclusive use of soft keys, the row of up arrow keys just below the display
- Combined use of the number keys and soft keys

For example, you may access a Pressure Source test as follows:

Soft keys only:

PRESSURE TESTS → STATIC PRESSURE → GAUGE → SOURCE

Combined:

3 STATIC PRESSURE → GAUGE → SOURCE

Either method is acceptable, and it is assumed that you will develop your own, most effective way of using the keys.

Error Messages

If you encounter any repeatable error messages, contact your Fluke Biomedical Service Center.

Pressure Tests

The following tests assess the integrity and accuracy of the Tester, as well as the instrument under test.

All tests begin from the **Main** menu:

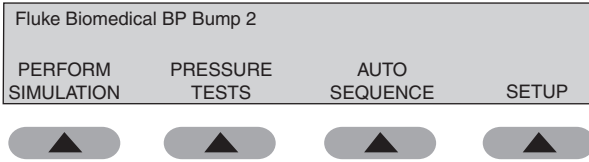

fas31.eps

After pressing the **PRESSURE TESTS** soft key to display the **Pressure Tests** menu, you can access the pressure tests described below:

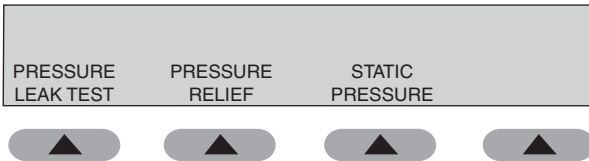

fas35.eps

Pressure Leak Test

The Pressure Leak Test pressurizes a pneumatic system to an operator-defined target pressure (labeled Setpoint) up to 400 mmHg (53.3 kPa) and then measures the loss of pressure over time.

To assess leakage, take the following actions:

1. Define the Setpoint by using the soft keys to follow the menu path shown below.

PRESSURE TESTS → PRESSURE LEAK TEST → SETUP

The **Leak Test (Setpoint)** screen appears.

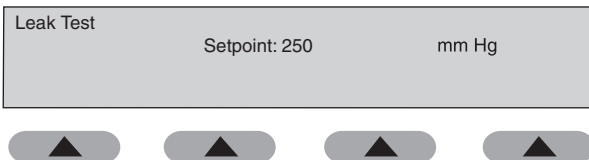

fas41.eps

2. Adjust the Setpoint by entering numbers with the number keys. The cursor moves to the next position after a number is entered

Note

Once defined, the Setpoint can be changed in increments of 1 least significant digit (LSD).

3. Press **ENT** to display the **Leak Test** screen.

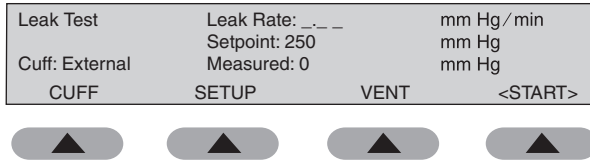

fas01.eps

4. Press the **VENT** soft key to release any unwanted pressure in the system before performing the test. This feature vents the system for approximately five seconds and can be repeated as needed to return pressure to zero.
5. Press the **<START>** soft key to make the Tester deliver air to the system.

Once the system under test reaches the target pressure, the test begins. The pressure leak rate of the system and the current system pressure are shown during the test. The leak rate is expressed in mmHg/min by default or can appear in kPa/min, cmH₂O/min, inH₂O/min, or psi/min, depending on the pressure measurement unit selection. The leak rate of the Tester is < 2 mmHg/minute.

Note

When testing with an NIBP monitor in the system, it is necessary to put the monitor in “Service” mode, because most monitors leave the system open to the atmosphere.

6. Press **HOME** to return to the **Main** menu.

Pressure Relief Test

The Pressure Relief Test increases the pressure in the pneumatic system until the relief valve on the NIBP monitor opens, or until the Setpoint is reached, whichever occurs first.

Note

Put the NIBP monitor in “Calibrate” or “Service” mode to close the vent valve, allowing the Tester to inflate the pneumatic system. Refer to the NIBP monitor’s service manual to find the method for entering “Service” mode.

To assess the effectiveness of the relief valve, do the following:

1. Use the soft keys to follow the menu path shown below.

PRESSURE TESTS → PRESSURE RELIEF → SETUP

The **Relief Valve Test (Setpoint)** screen appears.

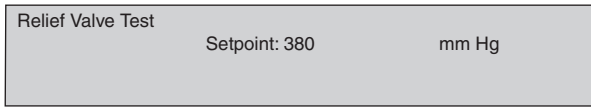

fas02.eps

2. If necessary, adjust the Setpoint, which defaults to 380 mmHg, by entering numbers with the number keys. The cursor moves to the next position after a number is entered.
3. Press **ENT** to display the **Relief Valve Test** screen.

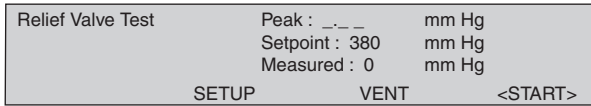

fas03.eps

4. Press the **VENT** soft key to release any unwanted pressure in the system before performing the test. This feature vents the system for approximately five seconds and can be repeated as needed to return pressure to zero.
5. Press the **<START>** soft key to make the Tester deliver air to the system.

While the Tester is delivering air to the system, the current pressure (Measured) and peak pressure are being monitored.

If the Setpoint is reached and the monitor does not release the pressure, the message **No Relief Detected** appears on the display.

Note

It is recommended that three pressure relief measurements be taken to check for a sticky relief valve.

Some NIPB monitors do not allow access to a “Service” mode, rendering it impossible to close a vent valve so that the system can be pressurized by an outside pump. As a last resort, it is possible to start a blood pressure determination with the monitor (this closes the valve), then start the Pressure Relief tests, so that two pumps inflate the system. The results can vary, but the monitor generally opens a relief valve at some high pressure.

6. Press **HOME** to return to the **Main** menu.

Pressure Source Test

The Pressure Source Test enables the Tester to simultaneously generate and measure pressure.

The Pressure Source Test can be used for static calibration of Non-Invasive blood pressure monitoring systems, checking sphygmomanometers, and evaluating any medical device that measures pressure in the ranges of 50 to 400 mmHg (6.7 to 53.3 kPa). Pressures can be generated in 1-mmHg (0.1 kPa) increments.

To perform a Pressure Source test, do the following:

1. Use the soft keys to follow the menu path shown below.

PRESSURE TESTS → STATIC PRESSURE → SOURCE → SETUP

The **Pressure Source (Setpoint)** screen appears.

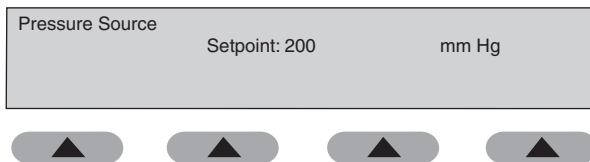

fas04.eps

2. If necessary, adjust the Setpoint, which defaults to 200 mmHg, by entering numbers with the number keys. The cursor moves to the next position after a number is entered.
3. Press **ENT** to display the **Pressure Source** screen.

Note

The **<START>** soft key is not applicable to the pressure gauge test and does not display.

3. Apply pressure to the pressure port and read the displayed pressure in the upper right corner of the screen.

Note

You can use a squeeze bulb or syringe to apply adequate pressure.

4. Press **HOME** to return to the **Main** menu.

Simulations

The following sections describe various simulations that the Tester accomplishes. For all of the following tests, it is important to select the correct cuff.

To perform simulations, take the following actions:

1. Power on the NIBP unit.

Note

Either disable the alarm or be prepared to silence it when it sounds.

2. Use the soft keys, beginning from the **Main** menu:

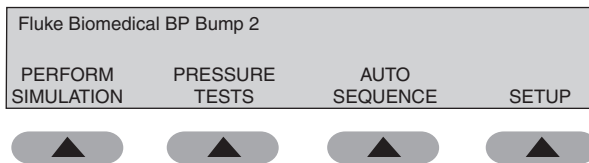

fas31.eps

3. Press the **PERFORM SIMULATION** soft key to access the **Select Simulation Type** menu. From this menu, you can access the simulations described below:

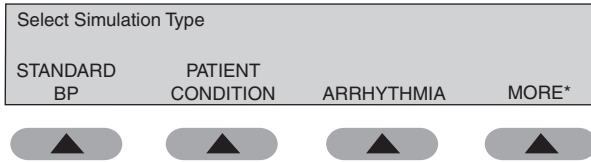

fas32.eps

4. Press the **MORE** soft key on this and the following screens for additional options:

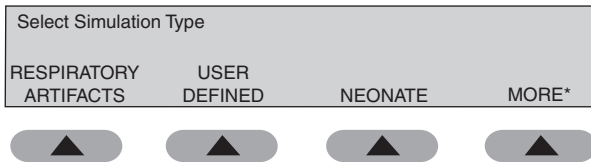

fas33.eps

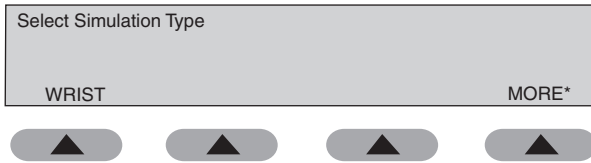

fas34.eps

Note

Alternatively, you can access all of the simulations from the number keys, which is the method described in this section.

Standard BP

The Tester provides many variations of NIBP simulations for both arm and wrist cuffs.

To perform Standard BP tests, do the following:

1. Access these simulations by pressing the **4 STANDARD BP** number key. The **Standard BP** screen appears.

Standard BP	ready	
Preset # 1	120/	80 (93)
Cuff: External	80 BPM	0.68 cc
OPTIONS	CUFF	



fas07.eps

2. Press the **OPTIONS** soft key to scroll through the simulation choices. Parameters for Standard BP simulations are shown in Table 3-2.

Table 3-2. Standard Blood Pressure Simulations

Simulation Number	Blood Pressure (mmHg) (MAP)	Heart Rate (bpm)	Pulse volume (cc)
1	120/80 (93)	80	0.68
2	150/100 (116)	80	0.65
3	200/150 (166)	80	0.60
4	255/195 (215)	80	0.55
5	60/30 (40)	80	0.75
6	80/50 (60)	80	0.71
7	100/65 (76)	80	0.69

3. Press the **CUFF** soft key to select Internal Adult or External cuff.
4. Press **Start** on the NIBP unit.
5. Compare values on the NIBP unit with those on the Tester.
6. Press **HOME** to return to the **Main** menu.

Patient Conditions

The Patient Condition simulations are intended to provide some basic patient variations.

To perform Patient Conditions simulations, do the following:

1. Access these simulations by pressing the **5 PATIENT CONDITIONS** key. The **Patient Condition** screen appears.

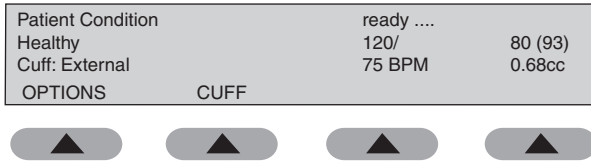

fas08.eps

- Press the **OPTIONS** soft key to scroll through the simulation choices. Parameters for Patient Condition simulations are shown in Table 3-3.

Table 3-3. Patient Condition Simulations

Patient Condition	Blood Pressure (mmHg) (MAP)	Heart Rate (bpm)	Pulse volume (cc)
Healthy Heart	120/80 (93)	75	0.68
Weak Pulse	110/80 (90)	95	0.50
Mild Exercise #1	140/90 (106)	120	1.00
Strenuous Exercise #2	140/90 (106)	162	1.40
Obese Subject	120/80 (93)	90	0.50
Geriatric Subject	150/110 (123)	95	0.40
Tachycardia	120/105 (110)	130	0.40
Bradycardia	120/60 (80)	45	1.10

- Press the **CUFF** soft key to select Internal Adult or External cuff.
- Press **Start** on the NIBP unit.
- Compare values on the NIBP unit with those on the Tester.
- Press **HOME** to return to the **Main** menu.

Arrhythmias

These waveforms cause erratic readings on some NIBPMs. The blood pressure determination strongly depends on exactly what is happening with the subject's blood pressure when the cuff pressure is at a particular level. Some NIBPMs pause until they detect two or more equivalent beats. The pattern of step deflations and the measured blood pressure depend on which beats occur during each step of the cuff pressure.

To perform Arrhythmia Simulations, do the following:

1. Access these simulations by pressing the **6 ARRHYTHMIA** key. The **Arrhythmia** screen appears.

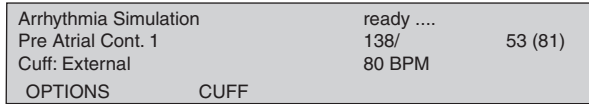

2. Press the **OPTIONS** soft key to scroll through the simulation choices. Parameters for Arrhythmia simulations are shown in Table 3-4.

fas09.eps

Table 3-4. Arrhythmia Simulations

Arrhythmia Type	Blood Pressure (mmHg) (MAP)	Heart Rate (bpm)
Premature Atrial Cont. #1	138/53 (81)	80
Premature Atrial Cont. #2	144/64 (90)	83
Premature Ventricular Cont.	118/61 (80)	83
Atrial Fib and PVCs	139/72 (94)	91

3. Press the **CUFF** soft key to select Internal Adult or External cuff.
4. Press **Start** on the NIBP unit.
5. Compare values on the NIBP unit with those on the Tester.
6. Press **HOME** to return to the **Main** menu.

Respiratory Artifacts

The Respiratory Artifact exhibits a beat-to-beat variation in the blood pressure caused by intra-thoracic pressure. Changes in the intra-thoracic pressure affect filling of the ventricles during diastole. This in turn affects the stroke volume of the heart. A large stroke develops a higher systolic pressure than a small stroke.

To perform Respiratory Artifact simulations, do the following:

1. Access these simulations by pressing the **7 RESPIRATORY ARTIFACT** key. The **Respiratory Artifact** screen appears.

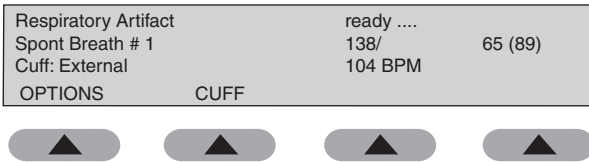

fas11.eps

2. Press the **OPTIONS** soft key to scroll through the simulation choices. Parameters for Respiratory Artifact simulations are shown in Table 3-5.

Table 3-5. Respiratory Artifact Simulations

Artifact Type	Blood Pressure (mmHg) (MAP)	Heart Rate (bpm)	Pulse volume (cc)
Spontaneous Breathing #1	138/65 (89)	104	Varies
Spontaneous Breathing #2	149/65 (93)	105	Varies
Spontaneous Breathing #3	112/47 (68)	86	Varies
Controlled Ventilation	132/44 (73)	98	Varies

3. Press the **CUFF** soft key to select Internal Adult or External cuff.
4. Press **Start** on the NIBP unit.
5. Compare values on the NIBP unit with those on the Tester.
6. Press **HOME** to return to the **Main** menu.

Neonate

The Neonate simulations are provided to test the ability of the NIBP monitors to detect blood pressure on neonatal patients.

To perform Neonate simulations, do the following:

1. Access these simulations by pressing the **8 NEONATE** key. The **Neonate Simulation** screen appears.

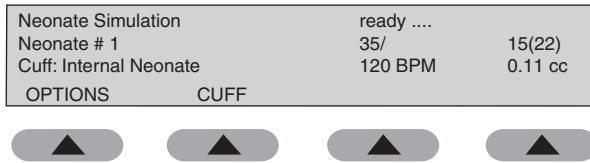

fas12.eps

2. Press the **OPTIONS** soft key to scroll through the simulation choices. Parameters for Neonate simulations are shown in Table 3-6.

Table 3-6. Neonate Simulations

Simulation Number	Blood Pressure (mmHg) (MAP)	Heart Rate (bpm)	Pulse volume (cc)
1	35/15 (22)	120	0.11
2	60/30 (40)	120	0.10
3	80/50 (60)	120	0.10
4	100/70 (80)	120	0.10

3. Press the **CUFF** soft key to select External or Internal Neonate.
4. Press **Start** on the NIBP unit.
5. Compare values on the NIBP unit with those on the Tester.
6. Press **HOME** to return to the **Main** menu.

Wrist

The Wrist simulations are provided to test wrist cuff NIBP monitors.

To perform Wrist simulations, do the following:

1. Access these simulations by pressing the **9 WRIST** key. The **Wrist Simulation** screen appears.

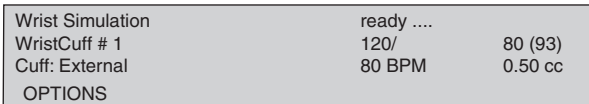

fas13.eps

2. Press the **OPTIONS** soft key to scroll through the simulation choices. The simulation is automatically set up to use the external cuff and cannot be changed. Parameters for Wrist simulations are shown in Table 3-7.

Table 3-7. Wrist Simulations

Simulation Number	Blood Pressure (mmHg) (MAP)	Heart Rate (bpm)	Pulse volume (cc)
1	120/80 (93)	80	0.50
2	160/100 (120)	80	0.50
3	80/55 (63)	80	0.50

7. Press **Start** on the NIBP unit.
8. Compare values on the NIBP unit with those on the Tester.
9. Press **HOME** to return to the **Main** menu.

User-Defined

User-Defined simulations and how to create them are described in “Setting Up the Tester.”

The following describes how to run such a simulation.

1. Select from any of the previously-defined simulations by pressing the **0** **USER DEFINED** key. The **User Defined** screen appears.

User Defined	ready	
Simulation 1:	120/	80
Cuff: External	75 BPM	0.70 cc
OPTIONS	CUFF	EDIT



fas15.eps

2. Press the **OPTIONS** soft key to scroll through the simulation choices.
3. Press the **CUFF** soft key to select **External**, **Internal Adult**, or **Internal Neonate** cuff.

Note

It is important to select the correct cuff.

4. Press **Start** on the NIBP unit.
5. Compare values on the NIBP unit with those on the Tester.
6. Press **HOME** to return to the **Main** menu.

Auto Sequences

It is possible to create up to nine customized auto sequences. An auto sequence contains all four pressure tests and five simulations. The operator can disable any of these tests or simulations. A printout of the auto sequence result can also be enabled. The operator must make a cuff selection; this determines what NIBP simulations are displayed for that selection.

Editing Auto Sequences

Use the following steps to edit an auto sequence:

1. Press the **AUTO SEQUENCE** soft key to access the **Auto Sequence** menu.

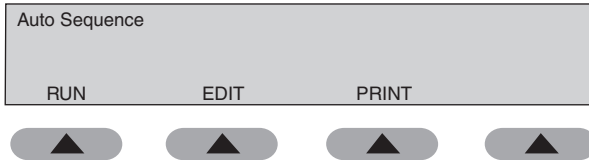

fas36.eps

2. Press the **EDIT** soft key.
3. At the **Select Auto Sequence** prompt, press a numeric key (**1-9**), followed by the **ENT** key. You are prompted to select, enable, or disable each of the components listed below. Press the **ENT** key at each of the prompts to advance to the next selection.
 - Print Auto Sequence Result
 - Pressure Gauge Test
 - Pressure Source Test
 - Pressure Leak Test
 - Pressure Relief Valve Test
 - Cuff Selection
 - NIBP Simulations (1-5)

Note

By default, each auto sequence is configured to perform the Leak Test, Relief Test, and BP Simulation #1 (120/80) Changing the cuff selection changes the available BP Simulation options.

4. When finished, either press the **RUN** soft key to run the sequence or press **HOME** to return to the **Main** menu.

Printing Auto Sequences

Use the following steps to print an auto sequence definition.

Note

Refer to ‘Setting up the Tester’ for printer output setup instructions.

1. To determine which tests and simulations are defined in an auto sequence, press the **AUTO SEQUENCE** soft key to access the **Auto Sequence** menu.

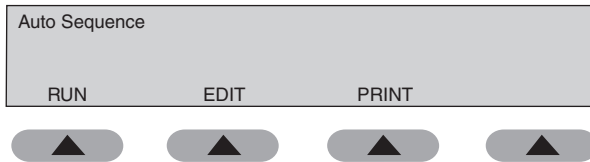

fas36.eps

2. Press the **PRINT** soft key. The **Select Auto Sequence (1-9)** screen appears.

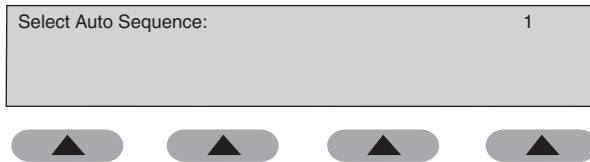

fas42.eps

3. Press a numeric key (**1-9**), followed by the **ENT** key.

Figure 3-7 shows a typical generated auto sequence printout.

```
Auto Sequence #1 Definition

Gauge Enabled
Leak Setpoint:           200 mmHg
Relief Pressure:         380 mmHg
Source Pressure:         200 mmHg

Cuff: External
Simulation 1:   Preset #1      120/80
                80BPM  0.7cc
Simulation 2:   Preset #2      150/100
                80BPM  0.7cc
Simulation 3:   Preset #3      200/150
                80BPM  0.7cc
Simulation 4:   Preset #4      255/195
                80BPM  0.7cc
Simulation 5:   Preset #5       60/30
                80BPM  0.7cc
```

Figure 3-7. Sample Auto Sequence Test Printout

Running Auto Sequences

Use the following steps to run an auto sequence.

1. Press the **AUTO SEQUENCE** soft key to access the **Auto Sequence** menu.

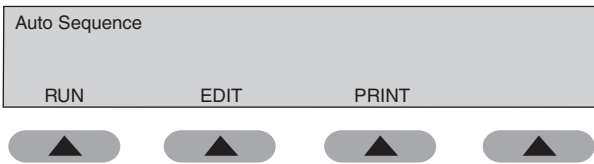

2. Press the **RUN** soft key. The **Select Auto Sequence (1-9)** screen appears.

fas36.eps

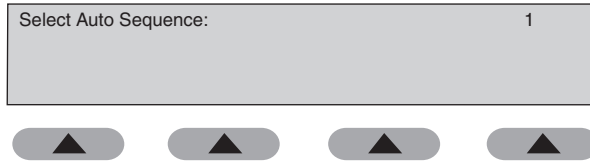

fas42.eps

3. Press a numeric key (**1-9**), followed by the **ENT** key.

The auto sequence begins to execute, based on the options that were enabled using the **EDIT** function.

Note

Tests and simulations not enabled in the executing auto sequence are skipped.

Enabled auto sequences are executed in the following order:

- Pressure Gauge Test
- Pressure Leak Test
- Pressure Relief Valve Test
- Pressure Source Test
- Data Sheet Printout
- NIBP Simulations

Pressure Gauge

This test monitors system pressure, which must be generated external to the Tester.

Press the **NEXT>** key to advance to the next test. Only the pressure displayed when the **NEXT>** key is pressed appears on the printout.

Leak Test

This test performs a system leak test at the Setpoint pressure, which was defined when the auto sequence was edited.

1. Press the **START** soft key to initiate this test. The system then pressurizes. Once a stable pressure reading near the Setpoint is reached, a 60-second timer begins to count down. Once the timer has elapsed, a Leak Rate appears on the display.

BP Pump 2

Operators Manual

2. If the Leak Rate is unsatisfactory, repair the possible cause of the leak and press **START** again to repeat the test.
3. Press the **NEXT>** key to advance to the next test. Only the leak rate displayed when the **NEXT>** key is pressed appears on the printout.

Note

*The **NEXT>** key will not function until the Leak Test has been performed at least once.*

Relief Valve Test

This test increases the pressure in the pneumatic system until the relief valve on the NIBP monitor opens or until the Setpoint is reached, whichever occurs first.

1. Press the **START** soft key to initiate this test. It is recommended that this test be repeated multiple times.
2. Press the **NEXT>** key to advance to the next test.

Note

*The **NEXT>** key will not function until the Relief Valve Test has been performed at least once.*

Pressure Source

This test causes the system to rise to the Setpoint pressure, which was defined when the auto sequence was edited.

1. Press the **START** soft key to initiate this test. The system then begins to pressurize until a stable pressure reading at or near the Setpoint is reached.
2. Record the monitor reading on the data sheet (if generated).
3. Press the **NEXT>** key to advance to the next test.

Note

*The **NEXT>** key does not function until the Pressure Source test has been performed.*

Data Sheet Printout

When this step is reached, a printout is generated, as shown in Figure 3-8, which includes a standard header, the results of the previous tests, a place to record data for the Pressure Source test (if enabled), and a list of BP Simulations that will be executed.

BP Simulations

At the conclusion of the auto sequence, up to five different blood pressure simulations are run in order of definition. Each simulation can be repeated as many times as desired; however, each defined simulation must be run at least once to advance to the next simulation.

Note

Some monitors cannot handle extreme changes in blood pressure. For example, it may not be possible to perform a 255/195 simulation following a 60/30 simulation on some monitors.

BP Pump 2
Operators Manual

Fluke Biomedical		
Tester Serial #:123456		
Date: _____	Time: _____	
Serial #: _____		
Control #: _____		
Mfg: _____		
Model: _____		
Location: _____		
Technician: _____		
Work Order: _____		
Procedure ID: _____		
Gauge: 181	mmHg	
Leak Test		
Leak Rate:	5 mmHg/min	
Start Pressure	203 mmHg	
End Pressure:	198 mmHg	
Relief Valve Test		
Peak Pressure:	418 mmHg	
No Relief Detected		
Pressure Source		
Actual:	_____	
Source:	186 mmHg	
Actual	___/___ ()	___BPM
Preset #1	120/80	80BPM 0.7cc
Actual	___/___ ()	___BPM
Preset #2	150/100	80BPM 0.7cc
Actual	___/___ ()	___BPM
Preset #3	200/150	80BPM 0.7cc
Actual	___/___ ()	___BPM
Preset #4	255/195	80BPM 0.7cc
Actual	___/___ ()	___BPM
Preset #5	60/30	80BPM 0.7cc

Figure 3-8. Sample Data Sheet Printout

Remote Operation

To prepare for remote operation, do the following:

1. Power down the Tester and connect the Tester to your PC, using a standard bidirectional RS-232 cable.
2. Turn the Tester on: the operating system recognizes the Tester as new hardware.

You are now ready to operate the Tester remotely.

RS-232 Settings

The Tester serial port parameters are fixed at the following settings:

- Baud Rate: 9600
- Parity: None
- Data Bits: 8
- Stop Bit: 1

Ansur Software Control

Ansur test automation systems allow a solutions-based approach to complete testing of the medical device under test (DUT). Ansur helps you create standard work using the test template/sequence (which is based on your written test procedure) and integrates all test results into a single test report that can be printed or archived. Ansur manages your test procedures by allowing both manual and visual automated test sequences.

The software works hand-in-hand with Fluke Biomedical testers and simulators, creating a seamless integration for:

- Visual inspections
- Preventive maintenance
- Work procedures
- Performance tests
- Safety tests

BP Pump 2

Operators Manual

Ansur software utilizes plug-in modules to work with a wide array of Fluke Biomedical instruments. The plug-in module is a software interface to the Ansur program. Plug-ins provide test elements used by Ansur. This gives the benefit of using the same user interface for all testers and simulators supported by an Ansur plug-in. See the *Fluke Biomedical Ansur BP Pump 2 Plug-in User Manual* for detailed information.

When you purchase a new Fluke Biomedical tester or simulator, you can update your existing Ansur software by installing a new plug-in. Each plug-in module lets you work only with the options and capabilities you need for the instrument you are testing. The Fluke Part Number for the Ansur BP Pump 2 Plug-in is 2755836.

Appendices

Appendix	Title	Page
A	ECG Interface	A-1
B	Questions and Answers.....	B-1
C	Abbreviations.....	C-1
D	Computer Control Commands	D-1

Appendix A

ECG Interface

Optional ECG Interface Adapter

The optional ECG Interface Adapter (Fluke Biomedical Part Number 2780512), shown in Figure A-1, is provided to aid in testing NIBP monitors that use ECG signals to assist in the detection of the pressure pulses. The ECG attachment is labeled with the five leads, RA, RL, LA, LL, and V, and is attached to the ECG Interface Port.

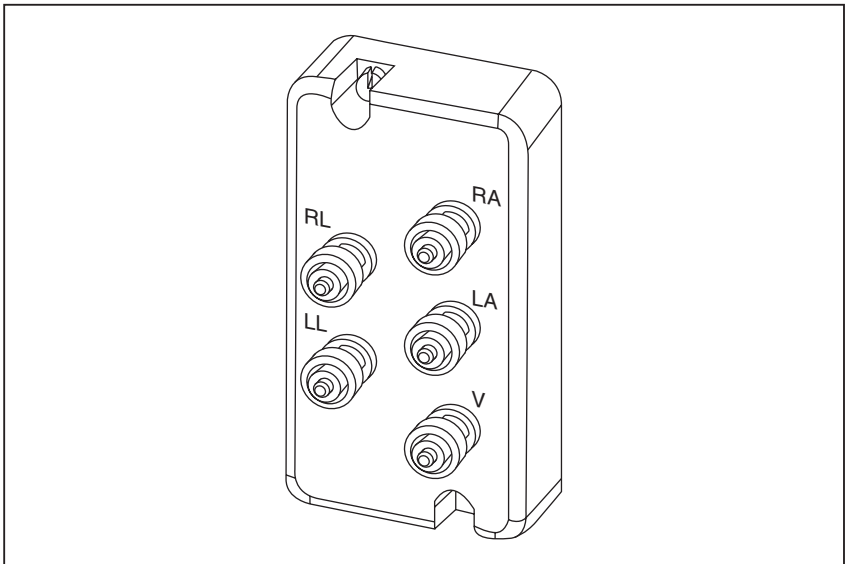

fas21.eps

Figure A-1. Optional ECG Interface Adapter

Using the optional ECG Interface Adapter (Part Number 2780512), the operator can observe simulated ECG signals that are in synchronization with

BP Pump 2

Operators Manual

the blood pressure simulations. These ECG signals are available for the Standard BP, Patient Conditions and Arrhythmias simulations.

Appendix B

Questions and Answers

Introduction

The following are questions submitted by customers and answered by members of our technical staff.

Blood Pressure Issues

Q: Monitor's BP determinations vary.

“I connected the Tester to my Critikon DINAMAP monitor and used the preset blood pressure of 120/80 (93) with a pulse rate of 80 beats per minute. I performed three blood pressure determinations with the following results:

Trial #	Systolic	Mean	Diastolic	Pulse Rate
1	123	97	82	79
2	126	93	81	81
3	123	97	83	78

Why does the blood pressure determined by the DINAMAP vary?”

A: Some variance is normal and acceptable.

The Tester generates a very repeatable simulation. For this simulation, an ideal NIBP monitor would show a variation of less than 2 mmHg from one simulation to the next. Most of the variation seen here originates in the DINAMAP. This is normal and acceptable.

Section 3.4.3 of the ANSI Standard for Electronic or Automated Sphygmomanometers specifies the required efficacy of the blood pressure determination:

“The mean difference of the paired measurements of the test system and the comparison system shall be ± 5 mmHg or less with a standard deviation of 8 mmHg or less.”

This means that variations in individual readings of 5, 6, or even 10 mmHg are quite normal and do not indicate that either the DINAMAP or the Tester are malfunctioning. Some monitors are more repeatable than others, and repeatability is one measure of the overall quality of the monitor.

Q: BP results vary using the same preset pressure.

“I checked another NIBP monitor using the same preset simulated blood pressure of 120/80 (93) with a pulse rate of 80 bpm. This time I got the following results:

Trial #	Systolic	Mean	Diastolic	Pulse Rate
1	120	89	71	80
2	120	87	73	80
3	121	91	72	80

Why does this monitor show such low Diastolic pressures?”

A: Monitors using different references – Auscultatory vs. Invasive data.

Neither the monitor nor the Tester is broken or giving incorrect readings.

Some monitors were designed to give readings close to those obtained by the Auscultatory method of blood pressure determination. Other monitors have been designed to agree with Invasive Blood Pressure readings. It is well known that Invasive and Auscultatory BP readings on the same subject can be quite different. Therefore it is not surprising that automated Oscillometric NIBP monitors using Invasive readings as a reference would give different readings than a monitor based on Auscultatory readings.

Cuff Issues

Q: Why is an Internal Cuff used?

“Why does the Tester use an Internal Simulated Cuff? Wouldn’t it be better to include a real cuff in the measurement?”

A: Internal Cuff produces accurate and repeatable simulations.

The Tester uses an internal cuff to help ensure accurate and repeatable simulations over time. The internal “cuff” is a 310-ml fixed volume that has compliance very nearly equal to a normal adult cuff when used at typical adult

mean pressures. Further, its compliance is constant over time and is independent of cuff wrapping technique.

The compliance of a standard cuff depends on the amount of air it contains. This, in turn, is dependent on what the cuff is wrapped around, and how tightly it is wrapped.

Q: Why is compliance Important?

“Why is tightly controlled compliance so important?”

A: Air in the cuff affects oscillations.

Blood pulsing through the arm surrounded by a cuff actually causes displacement of the air in the cuff. This must be converted into a pressure oscillation before the NIBP monitor can sense what is happening.

For a given volume displacement, the size of the pressure oscillation is inversely proportional to the volume of air in the cuff. Thus, a cuff full of air gives a smaller pressure oscillation than one wrapped tightly around the arm and containing little air.

The Tester works just like the subject’s arm. It creates a precisely controlled volume displacement. The cuff is what converts this displacement into a pressure oscillation.

By using an internal cuff of fixed volume, the Tester is assured of always producing the same pressure oscillation for each test.

Q. Can an External Cuff be used with the Tester?

“Can the Tester be used with an External Cuff?”

A. Connectors provided in Accessory Kit

The Tester can easily be configured to work with an External Cuff.

The available cuff options are accessible via the **CUFF** soft key present during the NIBP simulations.

Note

The exceptions are neonate, which allows only the internal neonate cuff, and wrist cuff, which allows only the external cuff.

The external cuff is included in the pneumatic circuit using the “Tee” or “Y” connectors in the accessory kit.

Appendix C

Abbreviations

Abbreviations

The following list includes abbreviations used in this document.

A	ampere
ANSI	American National Standards Institute
AAMI	Association for the Advancement of Medical Instrumentation
BLU	blue (color)
BPM	beats per minute
dB	decibel
°C	degrees Celsius (centigrade)
CQM	Contact Quality Monitor
DMM	digital multimeter
EEPROM	electrically erasable PROM
ECG	electrocardiograph or electrocardiogram
ESU	Electrosurgery Unit
EUT	equipment under test
°F	degrees Fahrenheit
GRA	gray (color)
GRN	green (color)

BP Pump 2
Operators Manual

Hz	hertz
in	inch
K	kilo (10^3)
kg	kilogram
kHz	kilohertz
k Ω	kilohm
lb	pound
LED	light-emitting diode
LCD	liquid crystal display
M	meg(a) (10^6)
MHz	megahertz
M Ω	megohm
m	meter
m	milli (10^{-3})
mA	milliampere
mm	millimeter
mV	millivolt
p-p	peak-to-peak
REM	Return Electrode Monitor
s	second
YEL	yellow (color)
μ	micro (10^{-6})
μ A	microampere
μ V	microvolt
Ω	ohm

Appendix D

Computer Control Commands

Introduction

The following commands are for use by software developers that have highly-developed technical knowledge. Operators should not try to control the Tester using these commands; rather, they should use Ansur test automation software.

The Tester acknowledges each valid computer control command that it receives. It responds to valid commands either with ACK (HEX 06), or ACK, followed by the data, followed by CR-LF (HEX 0D0A). A NAK (HEX 15) is returned for invalid commands.

The computer control commands are shown in Table D-1.

Table D-1. Computer Control Commands

Description	Command	Returned String
Internal Adult Cuff	[CUFF_IA]	ACK
Neonate Cuff	[CUFF_IN]	ACK
External Cuff	[CUFF_EXT]	ACK
Wrist Cuff Simulation	[SIM_WC120_80]	ACK
	[SIM_WC160_100]	ACK
	[SIM_WC80_55]	ACK

Table D-1. Computer Control Commands (cont.)

Description	Command	Returned String
Neonate Cuff Simulation	[SIM_NEO35_15]	NAK
	[SIM_NEO60_30]	NAK
	[SIM_NEO80_50]	NAK
	[SIM_NEO100_70]	NAK
Standard BP Simulation	[SIM_STD120_80]	ACK
	[SIM_STD150_100]	ACK
	[SIM_STD200_150]	ACK
	[SIM_STD255_195]	ACK
	[SIM_STD60_30]	ACK
	[SIM_STD80_50]	ACK
	[SIM_STD100_65]	ACK
Patient Conditions	[SIM_HEALTHY]	ACK
	[SIM_WEAK_PULSE]	ACK
	[SIM_MILDEX]	ACK
	[SIM_STRENEX]	ACK
	[SIM_OBESE]	ACK
	[SIM_GERIATRIC]	ACK
	[SIM_TACHYCARDIA]	ACK
	[SIM_BRADYCARDIA]	ACK

Table D-1. Computer Control Commands (cont.)

Description	Command	Returned String
Arrhythmias	[SIM_PAC1]	ACK
	[SIM_PAC2]	ACK
	[SIM_PVC]	ACK
	[SIM_AFIBPVC]	ACK
Respiratory Artifacts	[SIM_SB1]	ACK
	[SIM_SB2]	ACK
	[SIM_SB3]	ACK
	[SIM_CV]	ACK
Set Units of Blood Pressure	[BP_UNITS_KPA]	ACK
	[BP_UNITS_MMHG]	ACK
Set Units of Pressure	[PRESS_UNITS_KPA]	ACK
	[PRESS_UNITS_MMHG]	ACK
	[PRESS_UNITS_CMH2O]	ACK
	[PRESS_UNITS_INH2O]	ACK
	[PRESS_UNITS_PSI]	ACK

Table D-1. Computer Control Commands (cont.)

Description	Command	Returned String
Perform Leak Test at XXXmmHg	[LEAK,XXX] 50<=XXX<=400	Returns ACK then Leak Rate. Returns Leak Rate after 60 seconds, followed by CR-LF, or NAK if XXX out of range*
Perform Pressure Source at XXXmmHg	[PSOURCE,XXX] 50<=XXX<=400	ACK or NAK if XXX out of range
	[BLEED_SYSTEM]	ACK
Performs Relief Valve Test	[RELIEF,XXX] 50<=XXX<=400	Returns ACK then Peak Pressure, followed by CR-LF, or NAK if XXX out of range
Pressure Gauge	[GAUGE]	Returns ACK then pressure port value, followed by CR-LF

Table D-1. Computer Control Commands (cont.)

Description	Command	Returned String
	[BP_SERIAL]	Returns ACK then the serial number, followed by CR-LF
	[BP_VERSION]•	ACK then 2780201 Ver X.XX, followed by CR-LF•

